



50Ω TERMINATED 3 GHz SMA LATCHING D.P.3.T. SWITCH

OPTIONS /: TTL DRIVE

R F CHARACTERISTICS

FREQUENCY RANGE : 0 - 3 GHz
IMPEDANCE : 50 Ohms

FREQUENCY (GHz)	0 - 3
V.S.W.R	<= 1.20
INSERT. LOSS <=	0.20 dB
ISOLATION >=	80 dB
AVER. POWER (*)	120 W

ELECTRICAL CHARACTERISTICS

ACTUATOR : LATCHING
NOMINAL CURRENT AT 25° C (±10%) : 160 mA
ACTUATOR VOLTAGE (Vcc) : 28V (24 to 30V) / NEGATIVE COMMON
TERMINALS : solder pins (250° C max./30 sec.)
TTL INPUTS (E) - High level : 2.2 to 5.5V / 800µA at 5V
 - Low level : 0 to 0.8V / 20µA at 0.8V

MECHANICAL CHARACTERISTICS

CONNECTORS : SMA female per MIL C 39012
LIFE : 2.000.000 cycles
SWITCHING TIME (nominal voltage;25° C) : < 10 ms
CONSTRUCTION : splashproof
WEIGHT : < 100 g

ENVIRONMENTAL CHARACTERISTICS

OPERATING TEMPERATURE RANGE (°C) : -40 , +85
STORAGE TEMPERATURE RANGE (°C) : -55 , +85

(* : average power at 25° C)

4112-9212 This information is given as an indication. In the continual goal to improve our products, we reserve the right to make any modifications judged necessary

DRAWING

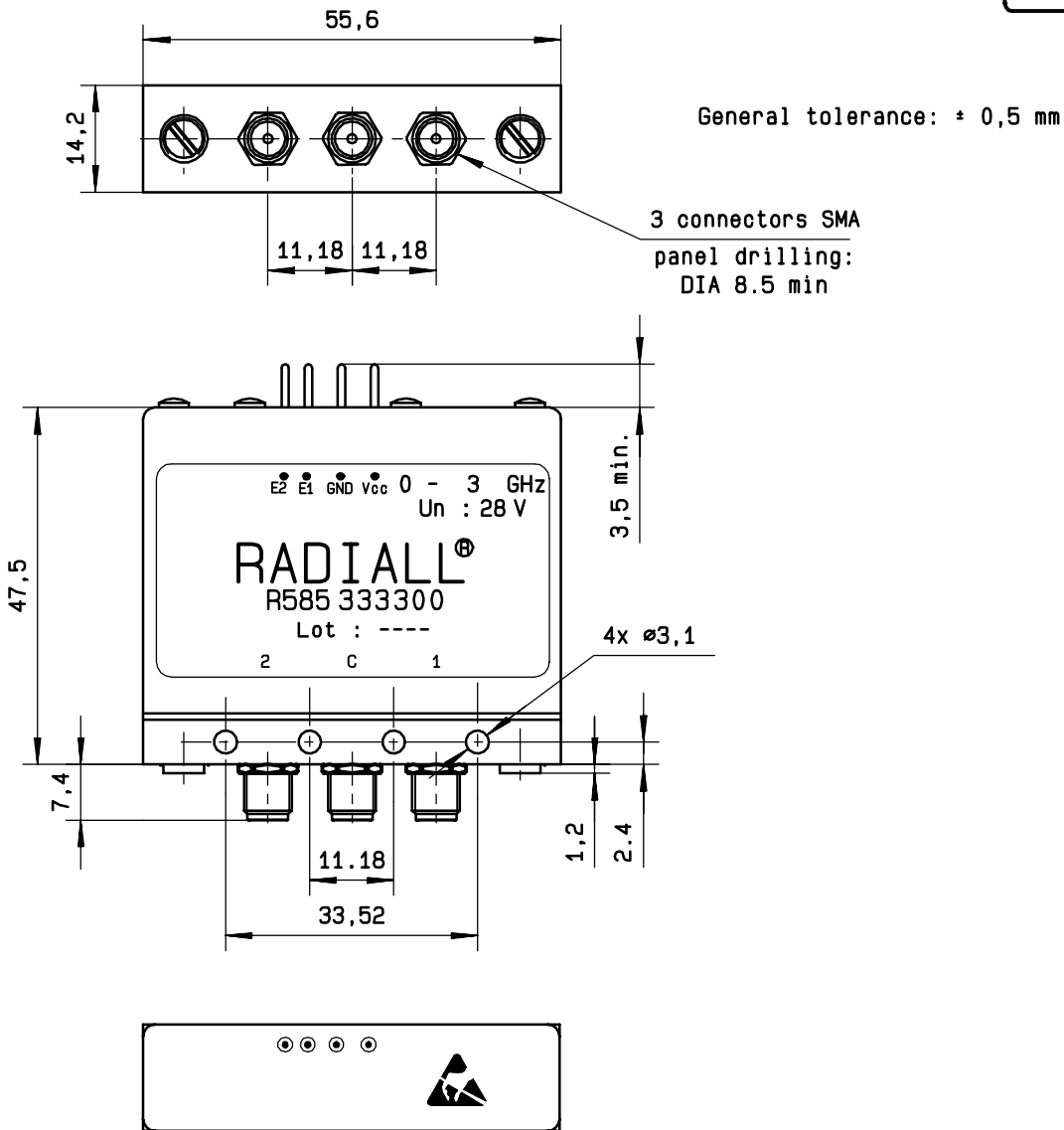

SCHEMATIC DIAGRAM

Voltage	RF continuity
E1=1 E2=0	C ↔ 1 / 2 ↔ 50Ω
E1=0 E2=1	C ↔ 2 / 1 ↔ 50Ω
E1=0 E2=0	Memory
E1=1 E2=1	Forbidden

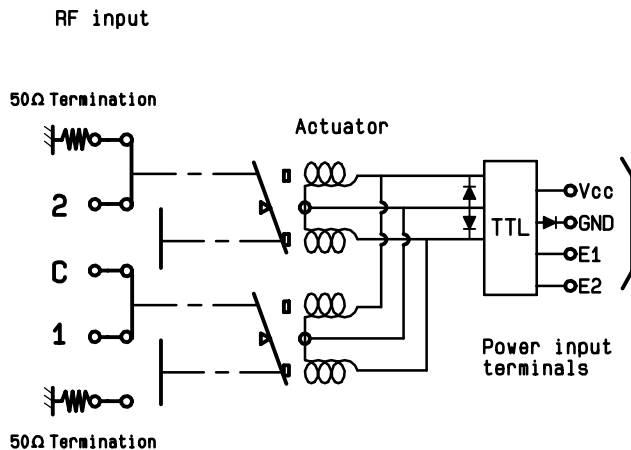

4113-9212 This information is given as an indication. In the continual goal to improve our products, we reserve the right to make any modifications judged necessary